



ReSound GN

ReSound Ligo™

# User guide

Behind-The-Ear hearing aids

GN Making Life Sound Better

Left Hearing Aid		Right Hearing Aid	
Serial number		Serial number	
Model		Model	
Battery size	<input type="checkbox"/> 312 <input type="checkbox"/> 13		

Open/ standard fitting:	<input type="checkbox"/> Small <input type="checkbox"/> Medium <input type="checkbox"/> Large	<input type="checkbox"/> Tulip	<input type="checkbox"/> Small <input type="checkbox"/> Medium <input type="checkbox"/> Large	<input type="checkbox"/> Earmould
	Open dome		Power dome	

Programme	Beep	Description
1	♪	
2	♪♪	
3	♪♪♪	
4	♪♪♪♪	

**NOTE:** Your hearing system might not support four environmental programmes. Ask your hearing care professional for details.

### Specific features supported by your hearing system:

- Smart Start on page 14
- Phone Now on page 24
- Telecoil on page 26
- Direct Audio Input on page 29
- Tinnitus Sound Generator on page 32
- Battery door lock on page 38

### Hearing aid type designations for models included in this user guide are:

**BE60**, FCC ID: X26BE60, IC: 6941C-BE60; **BE70**, FCC ID: X26BE70, IC: 6941C-BE70; **LO85**, FCC ID: X26LO85, IC: 6941C-LO85. Please see page 11 for a list of models referring to these types.

This device operates in the frequency range of 2.4 GHz - 2.48 GHz. This device includes an RF transmitter that operates in the range of 2.4 GHz - 2.48 GHz.

## 1 Introduction

Congratulations on the purchase of your new hearing aids. ReSound's innovative sound technology and design, combined with the customized programming selected by your hearing care professional, will make hearing a more enjoyable experience.

Please read this manual carefully in order to wholly benefit from the use of your hearing aids. With proper care, maintenance, and usage, your hearing aids will aid you in better communication for many years.

Ask your hearing care professional if you have any questions.

## 2 Intended use

Generic air-conduction hearing aids are wearable sound-amplifying devices intended to compensate for impaired hearing. The fundamental operating principle of hearing aids is to receive, amplify, and transfer sound to the eardrum of a hearing-impaired person.

## 3 Becoming accustomed to amplification

While purchasing hearing aids is a major step, it is only one step in a process toward more comfortable hearing. Successfully adapting to the amplification your hearing aids provide takes time and consistent use.

You will enjoy more benefits from your ReSound hearing aids by taking the following actions:

- Wear the hearing aids regularly in order to get comfortable with using them.

- It takes time to get used to hearing aids. It may help to begin by wearing them for short periods – even as little as 15 minutes – and then gradually increasing your wearing time. In a way, it is no different from adjusting to contact lenses. Speak to your hearing care professional, who can design a schedule tailored just for you.
- As you get more comfortable with them, increase the wearing time and wear your hearing aids in multiple types of listening environments.

It may take as long as several months for your brain to get used to all the “new” sounds around you. Following these suggestions will give your brain time to learn how to interpret amplification and increase the benefits you get from using ReSound hearing aids.

## 4 Statement

This device complies with part 15 of the FCC rules and ISED rules.

Operation is subject to the following two conditions:

1. This device may not cause harmful interference.
2. This device must accept any interference received, including interference that may cause undesired operation.



**NOTE:** This equipment has been tested and found to comply with the limits for a Class B digital device, pursuant to part 15 of the FCC rules and ISED rules. These limits are designed to provide reasonable protection against harmful interference in a residential installation. This equipment generates, uses and can radiate radio frequency energy and, if not installed and used in accordance with the instructions, may cause harmful interference to radio communications. However, there is no guarantee that interference will not occur in a particular installation. If this equipment does cause harmful interference to radio or television reception, which can be determined by turning the equipment off and on, the user is encouraged to try to correct the interference by one or more of the following measures:

- Reorient or relocate the receiving antenna.
- Increase the separation between the equipment and receiver.
- Connect the equipment into an outlet on a circuit different from the one in which the receiver is connected.
- Consult the dealer or an experienced radio/TV technician for help.

Changes or modifications can void the user's authority to operate the equipment.

The products comply with the following regulatory requirements:

- In EU: the device conforms to the Essential Requirements according to Annex I of Council Directive 93/42/EEC for medical devices (MDD).
- Hereby, GN ReSound A/S declares that the radio equipment types BE60, BE70 and LO85 are in compliance with Directive 2014/53/EU. The full text of the EU declaration of conformity is available at the following internet address: [www.declarations.resound.com](http://www.declarations.resound.com)
- In US: FCC CFR 47 Part 15, subpart C.

- Other identified applicable international regulatory requirements in countries outside the EU and US. Please refer to local country requirements for these areas.
- In Canada: these hearing aids are certified under the rules of ISED.
- Japanese Radio Law and Japanese Telecommunications Business Law Compliance. This device is granted pursuant to the Japanese Radio Law (電波法) and the Japanese telecommunications Business Law (電気通信事業法) This device should not be modified (otherwise the granted designation number will become invalid)

**Behind-the-ear (BTE) hearing aids of type BE60** with FCC ID X26BE60, IC number 6941C-BE60 and size **312** battery are available in the following variants:

LI767-DW, LI567-DW, LI467-DW

**Behind-the-ear (BTE) hearing aids of type BE70** with FCC ID X26BE70, IC number 6941C-BE70 and size **13** battery are available in the following variants:

LI777-DW, LI577-DW, LI477-DW

**Behind-the-Ear (BTE) hearing aids type LO85** with FCC ID X26LO85, IC number 6941C-LO85 and size **13** battery are available in following variants:

LI788-DW, LI588-DW, LI488-DW

The identification number for the BE60, BE70, and LO85 device models can be found at location "10" as indicated in the illustrations on the following pages.

## 5 Contents

1	Introduction.....	4	8.1	Using ReSound hearing aids with Smartphone apps.....	22	9.5.2	Available sounds.....	35	18	Important points for FM.....	50
2	Intended use.....	4				9.6	Prescription use of a Tinnitus Sound Generator (TSG) hearing aid.....	36	19	Tinnitus Sound Generator (TSG) warnings.....	51
3	Becoming accustomed to amplification.....	4	8.2	Cellular phones.....	23	9.7	Important notice for prospective sound generator users.....	36	19.1	TSG precautions.....	51
4	Statement.....	5	8.3	Phone Now.....	24				19.2	TSG warning to hearing care professionals.....	51
5	Contents.....	8	8.3.1	Placement of Phone Now magnets.....	24	10	Battery door lock for ReSound Ligo (optional).....	38	20	Battery warnings.....	53
6	Descriptions.....	10	8.3.2	Phone Now usage.....	25	11	How to apply domes.....	40	21	Hearing aid expectations.....	53
6.1	Your hearing aid – Ligo 67, 77 and 88.....	10	8.4	Telecoil (optional).....	26	11.1	ReSound domes.....	40	22	Warning to hearing aid professionals (US Only).....	54
6.2	Recognising left and right hearing aid.....	12	8.4.1	Tele loop systems.....	26	11.2	ReSound Tulip domes.....	40	23	Important notice for prospective hearing aid users (US Only).....	55
7	Getting started.....	14	8.4.2	HAC Telephone.....	27	12	Wireless accessories.....	41	24	Children with hearing loss (US Only).....	56
7.1	On/Off function.....	14	8.5	Direct Audio Input (optional).....	28	13	ReSound Assist (Optional).....	42	25	Technical specifications.....	57
7.1.1	Smart Start.....	14	8.5.1	Connecting DAI.....	29	14	Care and maintenance.....	43	25.1	Mini BTE.....	57
7.2	Inserting/Replacing the battery.....	14	8.5.2	Disconnecting DAI.....	29	14.1	Daily maintenance.....	44	25.2	BTE.....	58
7.3	Low battery indicator.....	16	8.6	Flight mode (optional).....	30	14.2	Cleaning earmoulds.....	44	25.3	Power BTE.....	59
7.3.1	Low battery indicator when paired with wireless accessories only.....	16	9	Tinnitus Sound Generator (TSG) module.....	32	14.3	Cleaning thin tubes and domes.....	45	26	Troubleshooting guide.....	60
7.4	Insert/Remove hearing aid.....	17	9.1	Intended use for the TSG module.....	32	15	General warnings.....	46	27	Warranties and repairs.....	64
7.4.1	Insert earmould.....	17	9.2	User instructions for the TSG module.....	32	16	Using ReSound hearing aids with ReSound apps for smartphones.....	48	28	Temperature test, transport and storage information.....	65
7.4.2	Remove earmould.....	18	9.2.1	Description of the device.....	32	16.1	Intended use of ReSound apps for smart- phones:.....	48			
7.4.3	Insert thin tube with dome.....	19	9.2.2	Explanation of how the device functions.....	32	16.2	General precautions.....	48			
7.4.4	Remove thin tube with dome.....	19	9.2.3	TSG volume control.....	33	17	Phone Now warnings.....	49			
7.5	Operation of the hearing aid.....	20	9.3	Using TSG with smartphone apps.....	34	17.1	Phone Now precautions.....	49			
7.5.1	Volume control (optional).....	20	9.4	The scientific concepts that form the basis for the device.....	34						
7.5.2	Programme button.....	21	9.5	Technical Specifications.....	34						
8	Telephone use.....	22	9.5.1	Audio signal technology.....	34						

## 6 Descriptions

### 6.1 Your hearing aid - LI 67/LI 77/LI 88

1. Push button
2. Battery door & On/Off switch
3. Sound outlet
4. Front microphone inlet
5. Back microphone inlet
6. Volume control (not for model 67)
7. Direct audio input (not for model 67)
8. Left/right indicator (Left = blue, Right = Red)
9. Battery lock (optional)
10. Model (in battery chamber)
11. Manufacturer
12. Serial number (in battery chamber)
13. Earhook
14. Earmould and tubing
15. Thin tube
16. Domes/earmould
  - a. Open dome
  - b. Tulip
  - c. Custom earmould

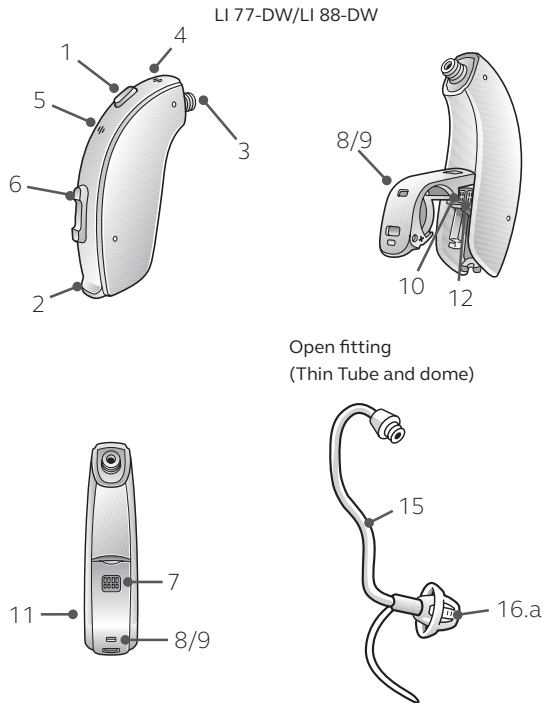

### Traditional fitting (earmould and tube)

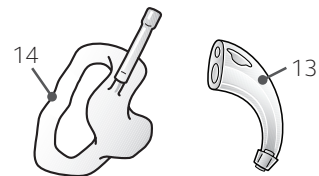

16.b



16.c

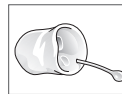

## 6.2 Recognising left and right hearing aid

If you have two hearing aids, they may be tuned differently. One for your left ear, the other for your right. Do not swap them. Please pay attention to this when cleaning, storing and inserting the hearing aids.

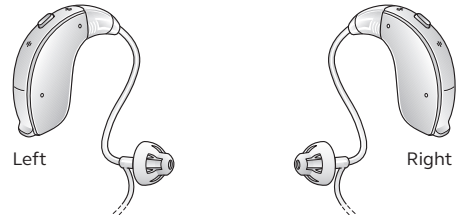

You might want to ask your hearing care practitioner to mark your hearing aids with a coloured Left and Right indication: Left is blue and Right is red.

## 7 Getting started

Once you have placed the hearing aids on your ears, you can turn them on.

The hearing aid always starts in programme 1 and with the pre-set volume.

### 7.1 On/Off function

1. Close the battery door to turn on the hearing aid in programme 1 (one).
2. Open the battery door to turn off the hearing aid. Use your fingernail to pull it open.

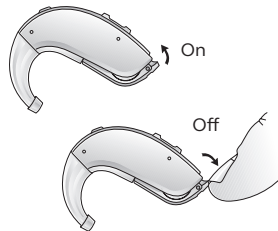

#### 7.1.1 Smart Start

Smart Start delays the time before the hearing aid turns on after you close the battery door. With Smart Start, you will hear a beep (♪♪♪ etc.) for each second of the delay period (5 or 10 seconds delay).

If you do not want to turn on the hearing aids prior to placing them on your ear, ask your hearing care professional to de-activate Smart Start.

### 7.2 Inserting/Replacing the battery

1. Open the battery door completely by using your fingernail. Remove the used battery if present.
2. Prepare the new battery (please refer to page 2 for information on appropriate battery type/size for your hearing aid). Remove the protective foil to activate the battery.
3. Wait for 2 minutes before inserting the battery into the hearing aid.

4. Insert the new battery with the positive side in the correct position. Always insert the battery in the door: never directly into the hearing aid.
5. Gently close the battery door.

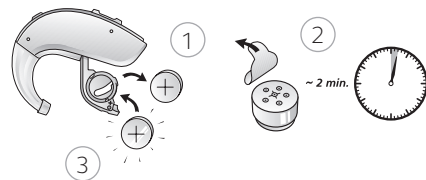

1. Always use new Zinc-Air batteries that have a minimum remaining shelf life of 1 year.
2. Whenever the hearing aids are not in use, remember to turn them off to avoid unnecessary battery consumption.
3. At night, switch off the hearing aid and open the battery door completely to allow moisture to evaporate and prolong the hearing aid's lifespan.
4. If the hearing aid is experiencing frequent loss of connection to ReSound wireless accessories contact your hearing care professional for a list of low impedance batteries.



**WARNING:** Batteries contain dangerous substances and should be disposed of carefully in the interest of your safety and for the environment. Also, keep batteries away from pets, children and mentally disabled persons.



### 7.3 Low battery indicator

The hearing aid will reduce amplification and play a melody if battery power gets too low. This signal will recur every 15 minutes until the hearing aid automatically switches off.

If you do not want the low battery warning, ask your hearing care professional to de-activate it.



**NOTE:** Keep spare batteries on hand.

#### 7.3.1 Low battery indicator when paired with wireless accessories only

The batteries drain faster when you use wireless functionalities like streaming sound from your TV with our TV Streamer. When the batteries deplete, the support of some ReSound wireless accessories shuts down. Full functionality returns when you insert a new battery.

The table below shows how the functionality decreases with the depletion of the batteries.

Battery level	Signal	Hearing aid	Remote Control	Streaming
Fully charged		✓	✓	✓
Low		✓	✓	x
Depleted (change battery)		✓	x	x

### 7.4 Insert/Remove hearing aid

For comfort, always turn off your hearing aids before you insert or remove them.

#### 7.4.1 Insert earmould

1. Hold the earmould between your thumb and index finger and position its sound outlet in your ear canal.
2. Slide the earmould all the way into your ear with a gentle, twisting movement.
3. Turn the top part of the earmould gently backwards and forwards so that it tucks behind the fold of skin above your ear canal.
4. Move the earmould up and down and gently press to place it correctly in the ear. Opening and closing your mouth can ease insertion.
5. Make sure the hearing aid sits firmly behind the ear.

By experimenting, you may discover an easier method. With proper insertion, hearing aids should fit snugly but comfortably.



**NOTE:** It may be helpful to pull your ear up and outward with your opposite hand during insertion.



**CAUTION:** Never attempt to modify the shape of the hearing aid, earmoulds, or tubing yourself.

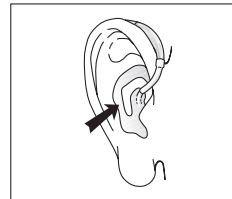
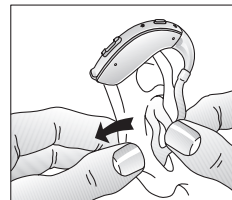
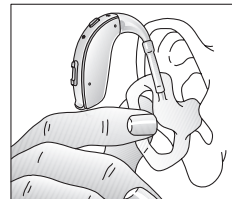

#### 7.4.2 Remove earmould

1. Lift the hearing aid from behind the ear. For a moment, let it hang beside your ear.
2. Using your thumb and index finger, gently pull the earmould (not the hearing aid or the tubing) loose from the ear.
3. Remove the earmould completely by gently twisting it.

#### 7.4.3 Insert thin tube with dome

1. Hang the hearing aid over the top of the ear.
2. Hold the thin tube where it bends and gently place/push the dome into the ear canal. Push the dome far enough into the ear canal so that the thin tube lies flush with the head (check with a mirror).

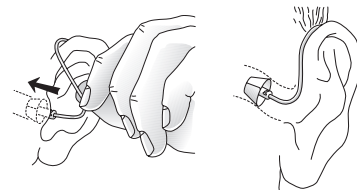

**NOTE:** To avoid whistling, it is important that the tube and the dome fit correctly into your ear. For other possible reasons, check with the Troubleshooting guide.



**CAUTION:** Never attempt to modify the shape of the hearing aid, earmoulds, or tubing yourself.

#### 7.4.4 Remove thin tube with dome

1. Hold the thin tube with your thumb and forefinger and remove the tube.
2. For thin tube custom earmoulds, grasp the removal string and pull the earmould outward.

## 7.5 Operation of the hearing aid

### 7.5.1 Volume control (not for LI67)

Your hearing aid has automatic volume control, which is individually set during the fitting session.

However, the volume control allows you to adjust the volume of your hearing aids to your liking.

1. To increase the volume, push the volume control up.
2. To decrease the volume, push the volume control down.

When you change the volume, the hearing aid responds with a beep. When you reach the upper or lower limits, the hearing aid responds with a low-pitched beep.

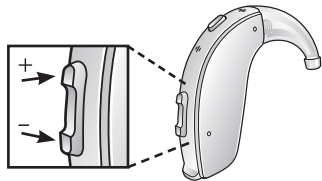

- i** **NOTE:** Not available for LI67.
- i** **NOTE:** If you have two hearing aids with the Synchronised Volume Control function enabled, volume control adjustments to one hearing aid automatically repeat in the second hearing aid. When you change the volume on one of the hearing aids, it responds with one or more beeps. A beep in the second aid follows.
- i** **NOTE:** Your hearing care professional can disable the volume control or replace the volume control with a non-functional cover.

### 7.5.2 Push button

Your hearing aid has a push button allowing you to use up to four different listening programmes. The list on page 2 tells which programs have been enabled.

1. Tap the push button to switch between programmes.
2. You will then hear one or more beeps. The number of beeps indicates which programme you have selected (one beep = programme one, two beeps = programme two, etc.).
3. When you turn the hearing aids off and then back on, they always return to the default setting (programme one and pre-set volume).

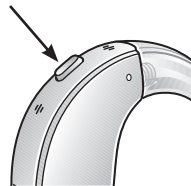

- i** **NOTE:** If you have two hearing aids with the Synchronised Push Button enabled, programme changes to one hearing aid automatically repeat in the second hearing aid. When you change a programme in one hearing aid, it responds with one or more beeps. The same number of confirmation beeps in the second aid follow.

## 8 Telephone use

Your hearing aid allows you to use the telephone as you ordinarily do. Finding the optimal position for holding a telephone may require practice. One or more of the following suggestions may be helpful:

1. Hold the telephone up to your ear.
2. Hold the telephone towards the top of the ear (closer to where the microphones are).
3. If whistling occurs, it may take a few seconds of holding the telephone in the same position before the hearing aid eliminates the feedback.
4. Whistling may stop by holding the telephone slightly away from the ear.

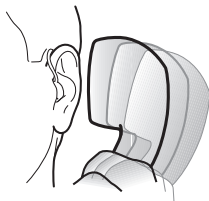

**NOTE:** Depending on your individual needs, your hearing care professional may activate a programme specifically for telephone use.

### 8.1 Using ReSound hearing aids with smartphone apps

Use with smartphone apps:

- Notifications of app updates should not be disabled, and it is recommended that the user installs all updates to ensure that the app will function correctly and will be kept up to date.
- The app must only be used with ReSound devices for which it is intended, and ReSound takes no responsibility if the app is used with other devices.
- If you would like a printed version of the user guide for a smartphone app, please consult customer support or go to our website at [www.resound.com/support](http://www.resound.com/support).

### 8.2 Cellular phones

Your hearing aid complies with the most stringent Standards of International Electromagnetic Compatibility. However, not all cell phones are hearing aid compatible (HAC).

Any degree of disturbance can be due to the nature of your particular cellular phone or of your wireless telephone service provider.



**NOTE:** If you find it difficult to obtain a good result while using your cellular phone, your hearing care professional will be able to give you advice on available wireless accessories to enhance listening capabilities.

## 8.3 Phone Now

The Phone Now function automatically switches your present listening programme to your telephone programme when a telephone receiver, equipped with a magnet, is close to your ear. When you remove the telephone receiver from your ear, the hearing aid automatically returns to the previous listening programme.

### 8.3.1 Placement of Phone Now magnets

Place Phone Now magnet on your telephone receiver to allow operation of the Phone Now function. In order to place Phone Now magnet properly:

1. Clean the telephone receiver thoroughly.
2. Hold the telephone vertically, in a position similar to when making a telephone call.
3. Place the magnets just below the telephone receiver. Make sure not to cover the microphone openings. If necessary, move the magnet to another position to improve ease of use and comfort while speaking.



**i** **NOTE:** If you are not satisfied with the strength of Phone Now, you can reposition the Phone Now magnet or add additional Phone Now magnets.

**NOTE:** Prior to placing the magnet on the telephone or cell phone, use a recommended cleaning agent to clean the telephone.

### 8.3.2 Phone Now usage

1. Use your telephone in a normal manner.
2. A short melody indicates that the Phone Now feature has automatically switched on the telephone programme.

**i** **NOTE:** Initially, you may need to move the telephone receiver slightly to find the best position for reliable Phone Now activation and good hearing on the telephone.

If you have two hearing aids with enabled Comfort Phone functionality, the hearing aid on the non phone ear automatically reduces the volume.

## 8.4 Telecoil (optional)

Your hearing aid may be equipped with a telecoil. The Telecoil programme may help to improve speech understanding with Hearing Aid Compatible telephones and in theatres, cinemas, houses of worship etc. that have tele-loop installed.

The telecoil cannot work without a tele-loop (a.k.a. induction-loop) or a Hearing Aid Compatible (HAC) telephone. When you switch on the Telecoil programme, your hearing aids pick up signals from the tele-loop or HAC telephone.

 **NOTE:** If you are having trouble hearing with the tele-loop, ask your hearing care professional to adjust the programme.

**NOTE:** If there is no sound from the hearing aids in a tele-loop system and an active Telecoil programme, the tele-loop system may not be turned on or is not operating correctly.

**NOTE:** Your hearing care professional will gladly provide information regarding a tele-loop system at your home. Ask your hearing care professional for more information.

### 8.4.1 Tele loop systems

To use tele loop systems, follow these steps:

1. Switch your hearing aid to the Telecoil programme.
2. Find a good spot. Reception is not clear in all locations; it depends on the induction loop. Look for signs or find another spot to sit.
3. If needed, adjust the volume.
4. When you leave, switch to a microphone programme.

### 8.4.2 HAC Telephone

The telecoil picks up the HAC telephone's telecoil signal and converts it to sound.

To use the HAC telephone, follow these steps:

1. Switch your hearing aid to the Telecoil programme.
2. Pick up the telephone and place a call or answer a call.
3. Hold the telephone behind your ear – close to the hearing aid, and tilt it slightly outwards.
4. Listen to the dialling tone and move the telephone to get the best reception.
5. If needed, adjust the volume.
6. When you hang up, switch to a microphone programme.

 **NOTE:** If the phone has a poor telecoil signal, use the microphone programme. To avoid whistling, do not hold the handset too tightly against your ear.

## 8.5 Direct Audio Input (optional)

Your hearing aid is equipped with a Direct Audio Input facility. Direct Audio Input allows direct connection of sound sources, a radio, television or even school equipment, to your hearing aid. Often, this will improve sound quality.



Direct audio

The sound source transmits to your hearing aid via a cable and a click-on device.

The hearing aid automatically detects the Direct Audio Input (DAI) source. The DAI supports the systems for wireless use as well.

Your hearing aid professional can adjust your hearing aids to fit the mix between the digital audio input and the microphones on your hearing aids. You may, e.g. select to lower the ambient sounds and amplify the sounds from the transmitter.

This accessory connects to the bottom of the hearing aids. Once clicked into place, the hearing aids automatically close the microphones and switch to DAI.



**NOTE:** DAI is not available for LI67.

### 8.5.1 Connecting DAI

1. Align the tip of the DAI click-on adaptor with the groove just above the battery door and below the model number.
2. Once in place, move the DAI click-on adaptor in the direction of the battery door.
3. Gently click the DAI click-on adaptor onto the hearing aid.



### 8.5.2 Disconnecting DAI

1. Press and hold the button on the front side of the DAI click-on adaptor.
2. Gently remove the DAI click-on adaptor from the hearing aid.



## 8.6 Flight mode (optional)

 **WARNING:** When boarding a flight or entering an area where RF transmitters are prohibited, wireless functionality must be deactivated.

Your ReSound Ligo hearing aid allows you to control it from your smartphone or ReSound Remote Control. However, in some areas you are requested to turn off wireless communication.

Follow these steps to turn off wireless mode:

1. For each hearing aid, open and close (open-close, open-close, open-close) the battery door three times within a 10-second period.
2. Double-dings for ten seconds (🎵🎵🎵 etc.) indicate that your hearing aid is in Flight mode.

Follow these steps to activate wireless mode:

1. For each hearing aid, open and close the battery door once.
2. Your hearing aids are in wireless mode after 10 seconds.

 **NOTE:** Both hearing aids must be set in Flight mode - even with synchronisation enabled.  
**NOTE:** It is important to wait an additional 15 seconds after wireless function resumes before opening and closing the battery door again for any reason. Flight mode will resume if you open and close the battery door during this 15-second window.



## 9 Tinnitus Sound Generator (TSG) module

### 9.1 Intended use for the TSG module

Your ReSound hearing aid includes the Tinnitus Sound Generator function, a tool for generating sounds to be used in tinnitus management programmes to relieve suffering from tinnitus.

The Tinnitus Sound Generator can generate sounds adjusted to the specific therapeutic needs and your personal preference as determined by your doctor, audiologist, or hearing care professional. Depending on the selected hearing aid programme and the environment you are in, you will sometimes hear the therapeutic sound resembling a continuous or fluctuating whistling.

### 9.2 User instructions for the TSG module

#### 9.2.1 Description of the device

The Tinnitus Sound Generator (TSG) Module is a software tool that generates sounds to be used in tinnitus management programmes to relieve suffering from tinnitus.

#### 9.2.2 Explanation of how the device functions

The TSG module is a frequency and amplitude shaped white-noise generator. Noise signal level and frequency characteristics can be adjusted to the specific therapeutic needs as determined by your doctor, audiologist or hearing care professional.

Your doctor, audiologist or hearing care professional can modulate the generated noise with the purpose of making it more pleasant. The noise can then resemble, for example, crashing waves on a shore.

Modulation level and speed can also be configured to your likes and needs. An additional feature can be enabled by your hearing care professional that allows you to select predefined sounds that simulate sounds from nature, such as breaking waves or running water.

If you have two wireless hearing aids that support ear-to-ear synchronisation this functionality can be enabled by your hearing care professional. This will cause the Tinnitus Sound Generator to synchronise the sound in both hearing aids.

If your tinnitus troubles you only in quiet environments, your doctor, audiologist or hearing care professional can set the TSG Module so that it becomes audible exclusively in such surroundings. The overall sound level can be adjusted via an optional volume control. Your doctor, audiologist or hearing care professional will review with you the need for having such a control.

For hearing aids where ear to ear synchronisation is enabled your hearing care professional can also enable environmental monitoring synchronisation so that the TSG noise level is automatically adjusted simultaneously in both hearing aids dependent on the background sound level. Additionally if the hearing aid has a volume control then the background noise level monitored by the hearing aid and the volume control can be used simultaneously to adjust the generated noise level in both hearing aids.

#### 9.2.3 TSG volume control

The sound generator is set to a specific loudness level by the hearing care professional. When switching the sound generator on, the volume will have this optimal setting. Therefore, it might not be necessary to control the volume (loudness) manually. However, the volume control provides the ability to adjust the volume, or amount of stimulus, to the liking of the user.

### 9.3 Using TSG with smartphone apps

The Tinnitus Sound Generator control via hearing aid push buttons can be enhanced with wireless control from a TSG control app on a smartphone or mobile device. This functionality is available in supported hearing aids when a hearing care professional has enabled the TSG functionality during fitting of the hearing aid.

To use smartphone apps the hearing aid must be connected with the smartphone or mobile device.

### 9.4 The scientific concepts that form the basis for the device

The TSG module provides sound enrichment with the aim of surrounding the tinnitus sound with a neutral sound, which is easily ignored. Sound enrichment is an important component of most approaches to tinnitus management, such as Tinnitus Retraining Therapy (TRT). To assist habituation to tinnitus, this needs to be audible. The ideal level of the TSG module, therefore, should be set so that it starts to blend with the tinnitus, and so that you can hear both your tinnitus as well as the sound used.

In a majority of instances, the TSG module can also be set to mask the tinnitus sound, so to provide temporary relief by introducing a more pleasant and controllable sound source.

## 9.5 Technical Specifications

### 9.5.1 Audio signal technology

Digital

### 9.5.2 Available sounds

White noise signal which can be shaped with the following configurations:

The white noise signal can be modulated in amplitude with an attenuation depth of up to 14dB.

High-pass filter	Low-pass filter
500 Hz	2000 Hz
750 Hz	3000 Hz
1000 Hz	4000 Hz
1500 Hz	5000 Hz
2000 Hz	6000 Hz

## 9.6 Prescription use of a Tinnitus Sound Generator (TSG) hearing aid

The TSG module should be used as prescribed by your doctor, audiologist or hearing care professional. In order to avoid permanent hearing damages, the maximum daily usage depends on the level of the generated sound.

Should you develop any side effects from using the sound generator, such as dizziness, nausea, headaches, perceived decrease in auditory function or increase in tinnitus perception, you should discontinue use of the sound generator and seek medical evaluation.

The target population is primarily the adult population over 18 years of age. This product may also be used with children 5 years of age or older. However, children and physically or mentally disabled users will require training by a doctor, audiologist, hearing care professional or the guardian for the insertion and removal of the hearing aid containing the TSG module.

## 9.7 Important notice for prospective sound generator users

A tinnitus masker is an electronic device intended to generate noise of sufficient intensity and bandwidth to mask internal noises. It is also used as an aid in hearing external noises and speech.

Good health practice requires that a person with a tinnitus condition have a medical evaluation by a licensed physician (preferably a physician who specializes in diseases of the ear) before using a sound generator. Licensed physicians who specialize in diseases of the ear are often referred to as otolaryngologists, otologists or otorhinolaryngologists.

The purpose of medical evaluation is to assure that all medically treatable conditions that may affect tinnitus are identified and treated before the sound generator instrument is used.

The sound generator instrument is a tool to generate sounds to be used with appropriate counselling and/or in a tinnitus management programme to relieve patients suffering from tinnitus.

## 10 Battery door lock for ReSound Ligo (optional)

Your hearing aid can be equipped with a lock on the battery door. The lock will impede children and mentally disabled persons from opening the battery door, thus minimising the risk of them accidentally swallowing the battery.

Once you lock the battery door, you can turn the hearing aid on and off. You have to unlock the battery door to replace the battery.

To lock the battery door of ReSound Ligo:

1. Open the battery door to its off position.
2. With the battery door in its off position, slide the battery lock slider to the right by pressing from the left side of the battery door.

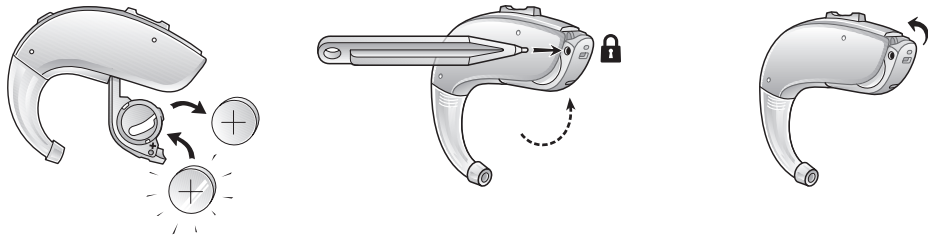

NOTE: Not available for LI67.

To unlock the battery door of ReSound Ligo:

1. With the battery door in its off position, slide the battery lock slider to the left by pressing from the right side of the battery door.

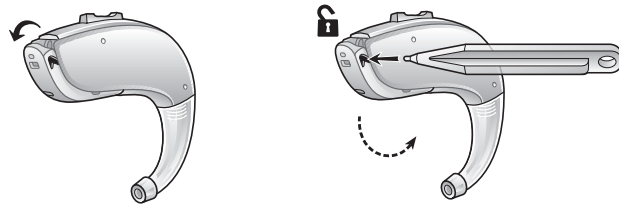

## 11 How to apply domes

It is recommended that your hearing care professional shows you how to change the domes, because incorrect dome replacement could result in the dome being left in the ear when you remove the hearing aid.

### 11.1 ReSound domes

Follow these steps to mount domes:

1. Push the new dome over the ribs flange on the thin tube.
2. Make sure that the new dome is properly and securely mounted.

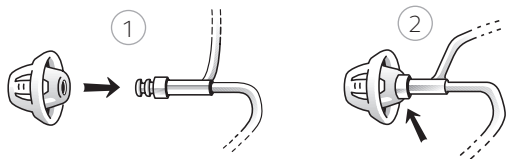

### 11.2 ReSound Tulip domes

The Tulip domes are mounted in a similar manner to the ordinary domes, but a few extra steps are required. The Tulip domes consist of two “petals”.

Follow these steps to mount domes:

1. Push the largest petal away from the thin tube using a finger. This bends the petal forward.
2. Push the new tulip dome over the flange.

3. Then push the largest petal backwards, and it will be placed on top of the smaller petal.

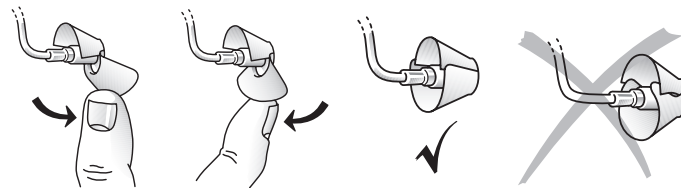

**NOTE:** It is important to note that the largest petal is the outermost petal.

4. Make sure that the new dome is properly and securely mounted.

## 12 Wireless accessories

With ReSound wireless accessories, you can stream sound from your TV or music player directly to your ReSound hearing aids and you can also control them without wearing an intermediary device around your neck.

Ask your hearing care professional for more information on the range of ReSound wireless accessories.

## 13 ReSound Assist (Optional)

If you sign up to use the ReSound Assist service available with your hearing aids, you can allow your hearing aids to be adjusted remotely without even having to travel from where you are at the moment. This allows you to experience unprecedented freedom and flexibility:

1. Request assistance remotely to adjust your hearing aids to be a better fit for you  
*Ask your hearing care professional for assistance or request adjustments to programs while installing the changes at your convenience – wherever you are*
2. Keep your hearing aid up to date with the latest software to ensure the best performance possible  
*Updates to the hearing aid software available for install at your convenience*

 **NOTE:** Your hearing aids shut down during the install and update process. For optimum performance, make sure the hearing aids are connected to the ReSound Smart 3D™ app and placed close to the iPhone or Android smartphone before applying the changes.

Your hearing care professional will gladly provide information regarding ReSound Assist, and how it works with the ReSound Smart 3D app.

## 14 Care and maintenance

Please follow the instructions below to have the best user experience and to prolong the durability of your hearing aids:

1. Keep your hearing aid clean and dry. Wipe the case with a soft cloth or tissue after use to remove grease or moisture. Do not use water or solvents, as these can damage the hearing aid(s).
2. Never immerse hearing aids in water or other liquids, as liquids may cause permanent damage to the hearing aids.
3. Avoid rough handling of hearing aids or dropping them on hard surfaces or floors.
4. Do not leave hearing aids in or near direct heat or sunlight, such as in a hot, parked car, as excessive heat can cause damage or deform the casing.
5. Do not wear your hearing aid while showering, swimming, in heavy rain or in a moist atmosphere such as a steam bath or sauna.
6. If your hearing aid does get wet, or if it has been exposed to high humidity or perspiration, it should be left to dry out overnight with the battery out and the battery door open. It is also a good idea to put the hearing aid and battery in a sealed container together with a drying agent (desiccator) overnight. Do not use the aid until it is completely dry. Consult your hearing care professional as to which drying agent to use.
7. Remove your hearing aid when applying cosmetics, perfume, aftershave, hair spray, and suntan lotion. These might get into the aid and cause damage.

### 14.1 Daily maintenance

It is important to keep your hearing aid clean and dry. On a daily basis, clean the hearing aids using a soft cloth or tissue. In order to avoid damage due to humidity or excessive perspiration, the use of a drying kit is recommended.

### 14.2 Cleaning earmoulds

1. Remove the earmould and attached tubing from the hearing aids prior to cleaning.
2. Clean the earmould using a mild soap, and rinse with lukewarm water.
3. After cleaning, dry earmoulds thoroughly and remove any residual water and debris from the tubing utilizing an air bulb and wire loop.

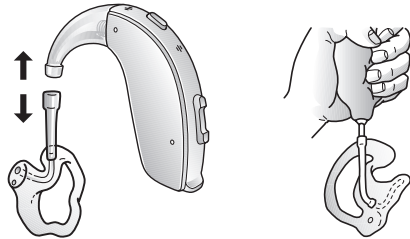

Pull the earmould and device apart.

 **NOTE:** Earmould tubing may become stiff, brittle, or discoloured over time. Contact your hearing care professional regarding tube changes.

### 14.3 Cleaning thin tubes and domes

1. Remove thin tubes from hearing aids before cleaning by unscrewing them counter clockwise.
2. Wipe down thin tubes and domes with a damp cloth.
3. In order to clear the thin tube of moisture and debris, push the black cleaning rod through the thin tube, beginning at the end opposite the dome.

 **NOTE:** We recommend that you change the thin tube and the dome systems every three months. If the components get stiff or brittle, change them sooner.

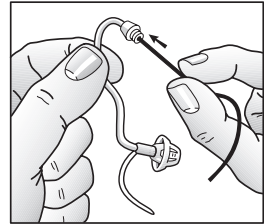

## 15 General warnings

1. Consult a hearing care professional if you think there may be a foreign object in your ear canal, if you experience skin irritation, or if excessive earwax accumulates with the use of the hearing aid.
2. Different types of radiation, from e.g. NMR, MRI, or CT scanners, may damage hearing aids. It is recommended not to wear hearing aids during these or other similar procedures. Other types of radiation, such as burglar alarms, room surveillance systems, radio equipment, mobile telephones, contain less energy and will not damage hearing aids. However, they have the potential to momentarily affect the sound quality or temporarily create undesired sounds from hearing aids.
3. Do not wear hearing aids in mines, oil fields, or other explosive areas unless those areas are certified for hearing aid use.
4. Do not allow others to use your hearing aids. This may cause damage to the hearing aids or to the hearing of the other individual.
5. Hearing Aid usage by children or mentally disabled persons should be supervised at all times to ensure their safety. The hearing aid contains small parts that could be swallowed by children. Please be mindful not to leave children unsupervised with this hearing aid.
6. Hearing aids should be used only as prescribed by your hearing care professional. Incorrect use may result in sudden and permanent hearing loss.
7. Warning to hearing care professionals: Special care should be exercised in selecting and fitting hearing aids with maximum sound pressure level that exceeds 132dB SPL with an IEC 60711:1981 occluded ear simulator. There may be a risk of impairment of the remaining hearing.
8. Be careful when boarding flights to deactivate the wireless functionality. Turn off your wireless functionality by using the flight mode in areas where radio frequency emission is prohibited.
9. If device is broken, do not use.

10. External devices connected to the electrical input must be safe according to the requirements of IEC 60601-1, IEC 60065, or IEC 60950-1, as appropriate (wired connection, for example HI-PRO), SpeedLink).



1. ReSound wireless devices include a RF transmitter that operates in the range of 2.4 GHz - 2.48 GHz.
2. Nominal RF output power transmitted is 0 dBm.
3. For use of wireless functionality only use ReSound wireless accessories. For further guidance regarding e.g. pairing, please refer to the user guide of the relevant ReSound wireless accessory.



## 16 Using ReSound hearing aids with ReSound apps for smartphones

### 16.1 Intended use of ReSound apps for smartphones:

ReSound smartphone apps are intended to be used with ReSound wireless hearing aids. ReSound smartphone apps send and receive signals from the ReSound wireless hearing aids via smartphones for which the apps have been developed.

### 16.2 General precautions

1. When wireless function is activated, the device uses low-powered digitally coded transmissions in order to communicate with other wireless devices. Although unlikely, nearby electronic devices may be affected. In that case, move the hearing aid away from the affected electronic device.
2. When using wireless functionality and the devices are affected by electromagnetic interference, move away from the source.
3. Use only original GN ReSound consumables e.g. tubes and domes.
4. Only connect ReSound hearing aids to ReSound wireless accessories intended and qualified to be used with ReSound hearing aids.

## 17 Phone Now warnings

1. Keep magnets out of reach of pets, children and people with mental disabilities. If a magnet is swallowed, please seek advice from a medical practitioner.
2. The magnet may affect some medical devices or electronic systems. The manufacturer of any magnetically sensitive devices (e.g. pacemakers) should advise you regarding appropriate safety precautions when using your hearing instrument and magnet in close proximity to the medical device or electronic system in question. If the manufacturer cannot issue a statement, we recommend keeping the magnet or a telephone equipped with the magnet 30 cm (12") away from magnetically sensitive devices (e.g. pacemakers).

### 17.1 Phone Now precautions

1. High distortion during dialling or phoning may mean that the magnet is not in the optimal position relative to the telephone receiver. To avoid the issue, please move the magnet to another place on the telephone receiver.
2. Only use magnets supplied by ReSound.

## 18 Important points for FM

1. Do not use two transmitters on the same FM channel.
2. Do not use water or fluids for cleaning the FM boot.
3. Do not use an FM transmitter in locations where it is forbidden to use electronic devices, for instance in airplanes.
4. Be aware that FM signals might also be picked up and overheard by other receivers.
5. Before using the system in another country, contact your hearing care professional to make sure your radio channel is permitted in that country.
6. Your FM boot and transmitter may only be repaired by an authorized service centre.

## 19 Tinnitus Sound Generator (TSG) warnings

1. Sound generators can be dangerous if improperly used.
2. Sound generators should be used only as advised by your doctor, audiologist, or hearing care professional.
3. Sound generators are not toys and should be kept out of reach of anyone who might cause themselves injury (especially children and pets).

### 19.1 TSG precautions

1. Should the user develop any side effects from using the sound generator, such as dizziness, nausea, headaches, perceived decrease in auditory function or increase in tinnitus perception, the user should discontinue use of the sound generator and seek medical evaluation.
2. Children and physically or mentally disabled users will require guardian supervision while wearing the TSG hearing aid.
3. The volume control is an optional feature in the TSG module used for adjusting the sound generator output level. To prevent unintended usage by paediatric or physically or mentally disabled users, the volume control must, if enabled, be configured to only provide a decrease of the sound generator output level.

### 19.2 TSG warning to hearing care professionals

A hearing care professional should advise a prospective sound generator user to consult promptly with a licensed physician (preferably an ear specialist) before getting a sound generator if the hearing care professional determines through inquiry, actual observation, or review of any other available information concerning the prospective user that the prospective user has any of the following conditions:

1. Visible congenital or traumatic deformity of the ear.
2. History of active drainage from the ear within the previous 90 days.
3. History of sudden or rapidly progressive hearing loss within the previous 90 days.
4. Acute or chronic dizziness.
5. Unilateral hearing loss of sudden or recent onset within the previous 90 days.
6. Audiometric air-bone gap equal to or greater than 15dB at 500 hertz (Hz), 1000 Hz, and 2000 Hz.
7. Visible evidence of significant cerumen accumulation or a foreign body in the ear canal.
8. Pain or discomfort in the ear.

 **CAUTION:** The maximum output of the sound generator falls into the range that can cause hearing loss according to OSHA regulations. In accordance with NIOSH recommendations, the user should not use the sound generator for more than eight (8) hours a day when set to a level of 85 dB SPL or above. When the sound generator is set to levels of 90 dB SPL or above, the user should not use the sound generator for more than two (2) hours per day. In no case should the sound generator be worn at uncomfortable levels.

## 20 Battery warnings

Batteries contain dangerous substances and should be disposed of carefully in the interest of your safety and for the environment. Please note:

1. Keep batteries away from pets, children and mentally disabled persons.
2. DO NOT place batteries in your mouth. Consult a physician immediately if a battery has been swallowed, as they can be harmful to your health.
3. Do not attempt to recharge batteries (Zinc Air) which are not specifically designated as rechargeable because they may leak or explode.
4. DO NOT attempt to dispose of batteries by burning them.
5. Used batteries are harmful to the environment. Please dispose of them according to local regulations or return them to your hearing care professional.
6. Remove the batteries to prevent leakage when the hearing aids are not in use for an extended period of time.

## 21 Hearing aid expectations

A hearing aid will not restore normal hearing and will not prevent or improve a hearing impairment resulting from organic conditions. Consistent use of the hearing aid is recommended. In most cases, infrequent use does not permit you to attain full benefit from it.

The use of a hearing aid is only part of hearing rehabilitation and may need to be supplemented by auditory training and instructions in lip-reading.

## 22 Warning to hearing aid professionals (US Only)

A hearing care professional should advise a prospective hearing aid user to consult promptly with a licensed physician (preferably an ear specialist) before dispensing a hearing aid if the hearing care professional determines through inquiry, actual observation, or review of any other available information concerning the prospective user, that the prospective user has any of the following conditions:

1. Visible congenital or traumatic deformity of the ear.
2. History of active drainage from the ear within the previous 90 days.
3. History of sudden or rapidly progressive hearing loss within the previous 90 days.
4. Acute or chronic dizziness.
5. Unilateral hearing loss of sudden or recent onset within the previous 90 days.
6. Audiometric air-bone gap equal to or greater than 15 decibels at 500 hertz (Hz), 1,000 Hz, and 2,000 Hz.
7. Visible evidence of significant cerumen accumulation or a foreign body in the ear canal.
8. Pain or discomfort in the ear.

## 23 Important notice for prospective hearing aid users (US Only)

Good health practice requires that a person with a hearing loss have a medical evaluation by a licensed physician (preferably a physician who specializes in diseases of the ear) before purchasing a hearing aid. Licensed physicians who specialize in diseases of the ear are often referred to as otolaryngologists, otologists or otorhinolaryngologists. The purpose of medical evaluation is to assure that all medically treatable conditions that may affect hearing are identified and treated before the hearing aid is purchased.

Following the medical evaluation, the physician will give you a written statement that states that your hearing loss has been medically evaluated and that you may be considered a candidate for a hearing aid. The physician will refer you to an audiologist or a hearing care professional, as appropriate, for a hearing aid evaluation. The audiologist or hearing care professional will conduct a hearing aid evaluation to assess your ability to hear with and without a hearing aid. The hearing aid evaluation will enable the audiologist or hearing care professional to select and fit a hearing aid to your individual needs. If you have reservations about your ability to adapt to amplification, you should inquire about the availability of a trial-rental or purchase-option programme. Many hearing care professionals now offer programmes that permit you to wear a hearing aid for a period of time for a nominal fee after which you may decide if you want to purchase the hearing aid.

Federal law restricts the sale of hearing aids to those individuals who have obtained a medical evaluation from a licensed physician. Federal law permits a fully informed adult to sign a waiver statement declining the medical evaluation for religious or personal beliefs that preclude consultation with a physician. The exercise of such a waiver is not in your best health interest and its use is strongly discouraged.

## 24 Children with hearing loss (US Only)

In addition to seeing a physician for a medical evaluation, a child with a hearing loss should be directed to an audiologist for evaluation and rehabilitation since hearing loss may cause problems in language development and the educational and social growth of a child. An audiologist is qualified by training and experience to assist in the evaluation and rehabilitation of a child with a hearing loss.

## 25 Technical specifications

### 25.1 Mini BTE

Models: LI767-DW, LI567-DW, LI467-DW

		Open	Closed	
Reference test gain (60 dB SPL input)	HFA	38	38	dB
Full-on gain (50 dB SPL Input)	Max	52	56	dB
	HFA	47	49	dB
Maximum output (90 dB SPL input)	Max	122	120	dB SPL
	HFA	114	115	dB SPL
Total harmonic distortion	500 Hz	0.4	0.5	%
	800 Hz	0.2	0.5	%
	1600 Hz	0.6	1.0	%
Telecoil sensitivity (SPLIV @ 31.6 mA/m)		100	99	dB SPL
Equivalent input noise (w/o noise reduction)		21	23	dB SPL
Frequency range (DIN 45605)		100-6980	100-6800	Hz
Current drain (in test mode)		1.2	1.3	mA

Data in accordance with IEC60118-0 Edition3.0 2015-06, IEC60118-7 and ANSI S3.22-2009, supply Voltage 1.3V

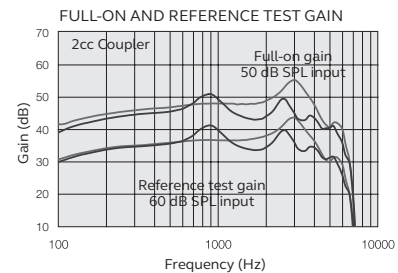
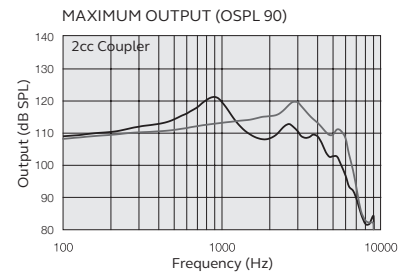

— Open configuration  
— Closed configuration

## 25.2 BTE

Models LI777-DW, LI577-DW, LI477-DW

		Open	Closed	
Reference test gain (60 dB SPL input)	HFA	38	43	dB
Full-on gain (50 dB SPL Input)	Max HFA	51 48	57 53	dB dB
Maximum output (90 dB SPL input)	Max HFA	127 116	124 121	dB SPL dB SPL
Total harmonic distortion	500 Hz	0.2	0.4	%
	800 Hz	0.2	0.8	%
	1600 Hz	0.6	0.7	%
Telecoil sensitivity (SPLIV @ 31.6 mA/m)		100	105	dB SPL
Equivalent input noise (w/o noise reduction)		22	20	dB SPL
Frequency range (DIN 45605)		100-6810	100-6140	Hz
Current drain (in test mode)		1.2	1.2	mA

Data in accordance with IEC60118-0 Edition3.0 2015-06, IEC60118-7 and ANSI S3.22-2009, supply Voltage 1.3V

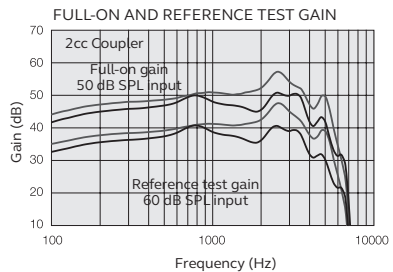
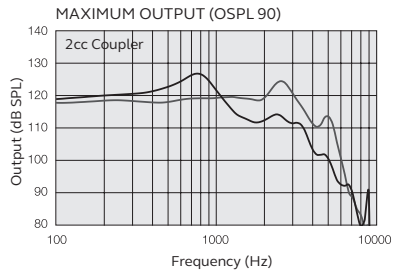

— Open configuration  
— Closed configuration

## 25.3 Power BTE

Models LI788-DW, LI588-DW, LI488-DW

		Closed	
Reference test gain (60 dB SPL input)	HFA	51	dB
Full-on gain (50 dB SPL Input)	Max HFA	66 60	dB dB
Maximum output (90 dB SPL input)	Max HFA	132 128	dB SPL dB SPL
Total harmonic distortion	500 Hz	0.7	%
	800 Hz	0.2	%
	1600 Hz	0.4	%
Telecoil sensitivity (SPLIV @ 31.6 mA/m)		112	dB SPL
Equivalent input noise (w/o noise reduction)		21	dB SPL
Frequency range (DIN 45605)		100-5050	Hz
Current drain (in test mode)		1.3	mA

Data in accordance with IEC60118-0 Edition3.0 2015-06, IEC60118-7 and ANSI S3.22-2009, supply Voltage 1.3V

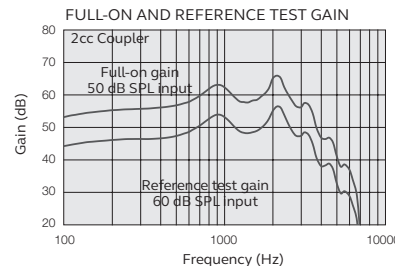
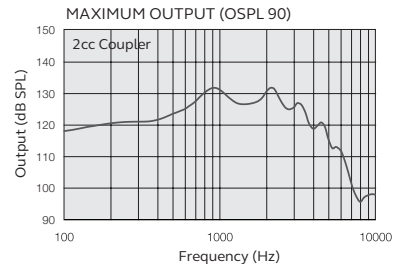

## 26 Troubleshooting guide

SYMPTOM	CAUSE	POSSIBLE REMEDY
Feedback, “whistling”	Is your earmould or dome inserted correctly?	Put it in again.
	Is the volume very loud?	Reduce it.
	Is the plastic tube or the earmould clogged or broken?	Replace or visit your hearing care professional.
	Are you holding an object (e.g. a hat, a telephone receiver) close to a hearing aid?	Move your hand away to create more space between the hearing aid and the object.
	Is your ear full of wax?	Visit your physician.
No sound	Is the hearing aid turned on?	Switch it on.
	Is the hearing aid in telecoil mode?	Switch to the microphone program.
	Is there a battery in the hearing aid?	Insert a new battery.
	Is the battery still good?	Replace with a new one.
	Is the plastic tube or the earmould clogged or broken?	Visit your hearing care practitioner.
	Is your ear full of wax?	Visit your physician.

SYMPTOM	CAUSE	POSSIBLE REMEDY
Sound is distorted, spluttering or weak?	Is the battery dead?	Replace it with a new one.
	Is the battery dirty?	Clean it or replace it with a new one.
	Is the plastic tube or the earmould clogged or broken?	Visit your hearing care professional.
	Did your hearing aid get moist?	Use a desiccant.
Battery drains very quickly	Did you leave your hearing aid switched on for long periods of time?	Always switch off your hearing aid when you are not using them, e.g. during the night.
	Is the battery old?	Check the date on the battery packaging.



## 27 Warranties and repairs

ReSound provides a warranty on hearing aids in the event of defects in workmanship or materials, as described in applicable warranty documentation. In its service policy, ReSound pledges to secure functionality at least equivalent to the original hearing aid. As a signatory to the United Nations Global Compact initiative, ReSound is committed to doing this in line with environment-friendly best practices. Hearing aids therefore, at ReSound's discretion, may be replaced by new products or products manufactured from new or serviceable used parts, or repaired using new or refurbished replacement parts. The warranty period of hearing aids is designated on your warranty card, which is provided by your hearing care professional.

For hearing aids that require service, please contact your hearing care professional for assistance. ReSound hearing aids that malfunction must be repaired by a qualified technician. Do not attempt to open the case of hearing aids, as this will invalidate the warranty.

## 28 Advisories

ReSound hearing aids are subjected to various tests in temperature and damp heating cycling between -25 °C and +70 °C according to internal and industry standards. During transport or storage, the temperature should not exceed the limit values of -20 °C to +60 °C and relative humidity of 90% RH, non-condensing (for limited time). The air pressure between 500 and 1100 hPa is appropriate.



**WARNING** points out a situation that could lead to serious injuries.



**CAUTION** indicates a situation that could lead to minor and moderate injuries.



Advice and tips on how to handle your hearing aid better.



Equipment includes an RF transmitter.



PLEASE ASK YOUR LOCAL HEARING CARE PROFESSIONAL CONCERNING DISPOSAL OF YOUR HEARING AID.



**NOTE:** Country specific regulations apply.



Follow instructions for use.

Portions of this software are written by Kenneth MacKay (micro-ecc) and licensed under the following terms and conditions:

Copyright © 2014, Kenneth MacKay. All rights reserved.

Redistribution and use in source and binary forms, with or without modification, are permitted provided that the following conditions are met:

- \* Redistributions of source code must retain the above copyright notice, this list of conditions and the following disclaimer.
- \* Redistributions in binary form must reproduce the above copyright notice, this list of conditions and the following disclaimer in the documentation and/or other materials provided with the distribution.

THIS SOFTWARE IS PROVIDED BY THE COPYRIGHT HOLDERS AND CONTRIBUTORS “AS IS” AND ANY EXPRESS OR IMPLIED WARRANTIES, INCLUDING, BUT NOT LIMITED TO, THE IMPLIED WARRANTIES OF MERCHANTABILITY AND FITNESS FOR A PARTICULAR PURPOSE ARE DISCLAIMED. IN NO EVENT SHALL THE COPYRIGHT HOLDER OR CONTRIBUTORS BE LIABLE FOR ANY DIRECT, INDIRECT, INCIDENTAL, SPECIAL, EXEMPLARY, OR CONSEQUENTIAL DAMAGES (INCLUDING, BUT NOT LIMITED TO, PROCUREMENT OF SUBSTITUTE GOODS OR SERVICES; LOSS OF USE, DATA, OR PROFITS; OR BUSINESS INTERRUPTION) HOWEVER CAUSED AND ON ANY THEORY OF LIABILITY, WHETHER IN CONTRACT, STRICT LIABILITY, OR TORT (INCLUDING NEGLIGENCE OR OTHERWISE) ARISING IN ANY WAY OUT OF THE USE OF THIS SOFTWARE, EVEN IF ADVISED OF THE POSSIBILITY OF SUCH DAMAGE.

© 2019 GN Hearing A/S. All rights reserved. ReSound is a trademark of GN Hearing A/S. The Bluetooth word mark and logos are registered trademarks owned by the Bluetooth SIG, Inc.



Manufacturer according to EU Medical  
Device Directive 93/42/EEC:

#### **Worldwide Headquarters**

GN ReSound A/S  
Lautrupbjerg 7  
DK-2750 Ballerup  
Denmark  
Tel.: +45 4575 1111  
resound.com

CVR no. 55082715

#### **New Zealand**

GN Hearing New Zealand Limited  
Ground Floor, North Entrance  
4 Fred Thomas Drive  
Takapuna, Auckland, 0622  
Tel.: (free) 0800 900 126  
resound.com

#### **United Kingdom**

GN Hearing UK Ltd.  
Kirtlington Business Centre  
Portway, Kirtlington  
Oxon OX5 3JA  
Tel.: +44 1869 352 800  
resound.com

#### **Australia**

GN Hearing Australia Pty Ltd.  
Gate C, 19-25 Khartoum Road  
Macquarie Technology Park  
Macquarie Park NSW 2113  
Tel.: (free) 1800 658 955  
resound.com

#### **Singapore**

GN Hearing Pte. Ltd.  
2 Kallang Avenue  
#07-19 CT HUB  
Singapore - 339407  
Tel: +65 6320 9388  
resound.com



Any issues relating to the EU Medical Device Directive 93/42/EEC or EU Radio  
Equipment Directive 2014/53/EU should be directed to GN ReSound A/S

**ReSound GN**  
.....